



ENVIRO 3 SPECIFICATIONS

ENVIRO 3
UNIT NUMBER:
99-EN-0003

WATER SEPARATOR FILTER
ELEMENTS PART NUMBER:
47-FMP101305

RETURN FILTER
ELEMENTS PART NUMBER:
47-LE03AZP (2 Micron)

4527 Losee Road • N. Las Vegas, NV. 89031 • Phone: (888) 287-1627 • Fax: (702) 639-4101

Internet: www.jchfuel.com • E-mail: sales@jchfuel.com

Introduction

THE ENVIRO Monitoring and Fuel Conditioning Systems, by JCH Fuel Solutions were designed to keep a pristine state of middle distillate fuel in the main storage tank.

THE ENVIROS not only give you healthy fuel to run your equipment, but a clean storage tank at the same time.

THE ENVIRO 3 system has been automated with a SIEMENS LOGO! (PLC) Programmable Logic Controller for ease of use and maintenance.

We are monitoring the system for fuel contamination levels. The contamination level will reach a saturation point and alert the user of its maintenance needs. The alarms can also be interfaced with central plant monitoring for the customer's convenience. The maintenance can be scheduled and the system can be brought back on line. **THE ENVIRO 3** is a wall mounted closed-loop system with built-in diagnostics. This will meet the environmental issues for a safe operation

THE ENVIRO systems were designed for complete fuel remediation and control.

JCH Fuel Solutions is providing excellent fuel quality for today's equipment.

General Specifications

Enviro 3

Wall Mounting	30"W x 36"H x 10"D
Flow Rate	8gpm - 480gph
Electrical	120 VAC, 6.8A, 50/60Hz
	Single Phase
Motor	1/2 HP, Single Phase
	120 VAC, 5.6A, 50/60Hz
Inlet	3/4" NPT Female
Outlet	3/4" NPT Female
Maximum Pressure.....	50 PSIG
System Weight (Empty).....	220 lbs.
System Weight (Operational)	230 lbs.

Enviro 3 Main Enclosure

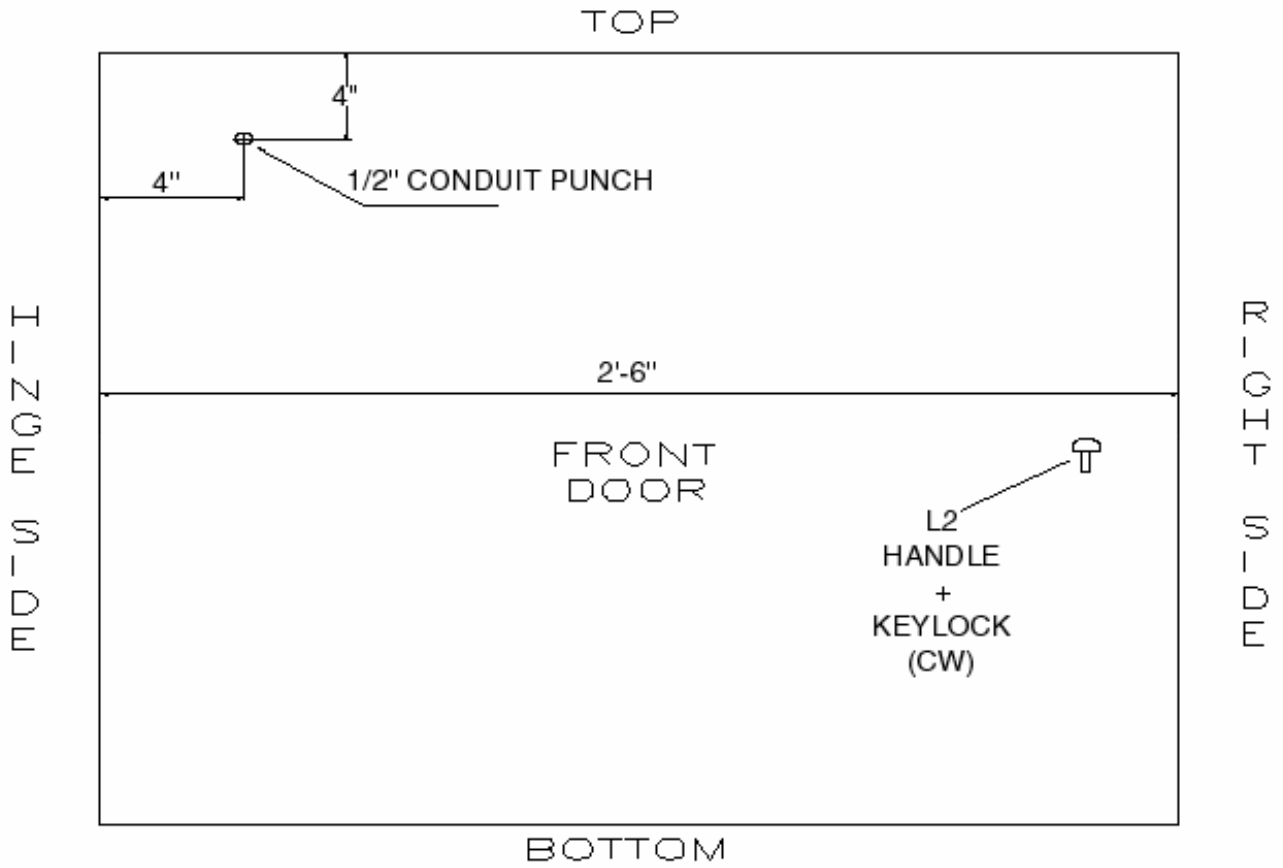

Enviro 3 Main Enclosure

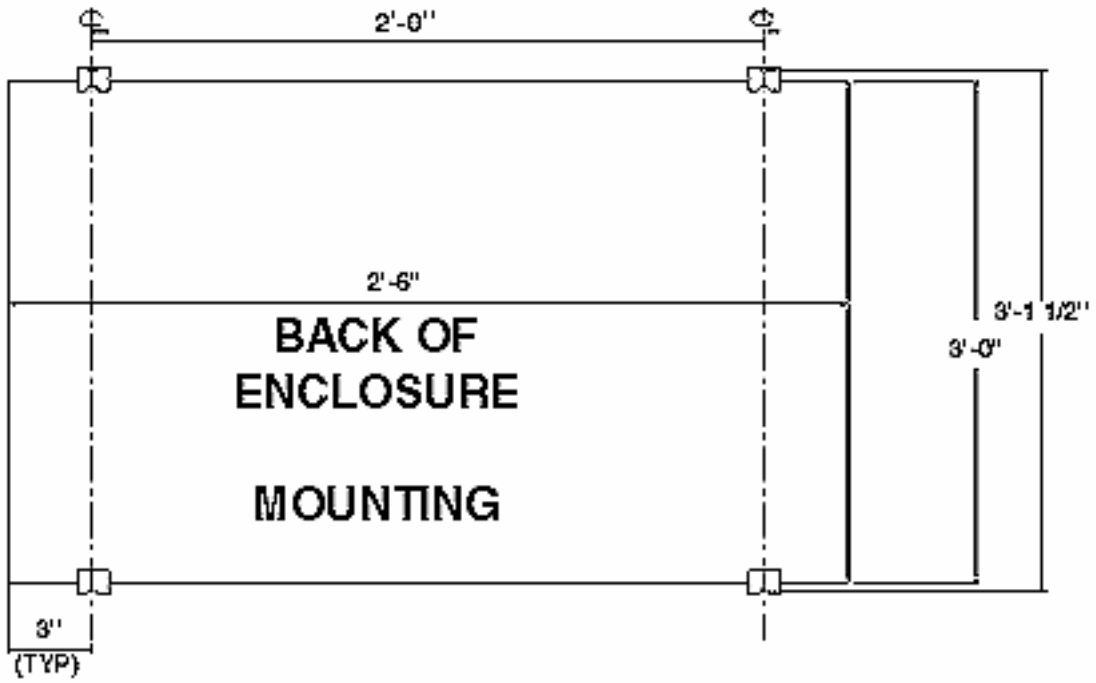

Enviro 3 Main Enclosure

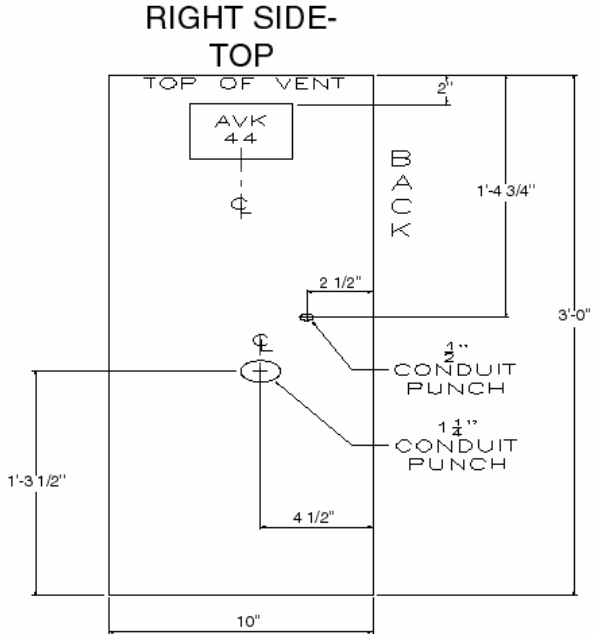
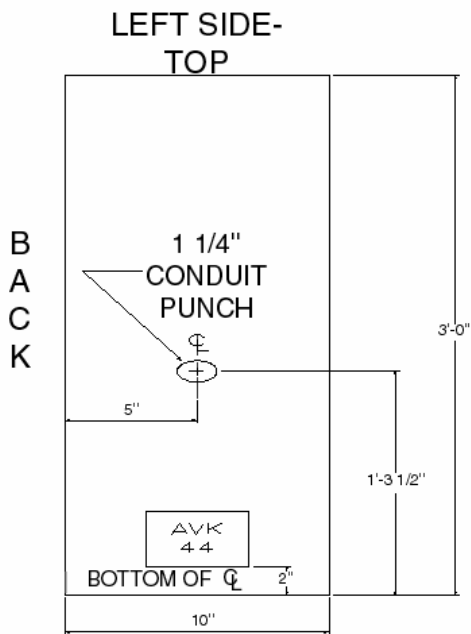

System Internal - Internal Identification

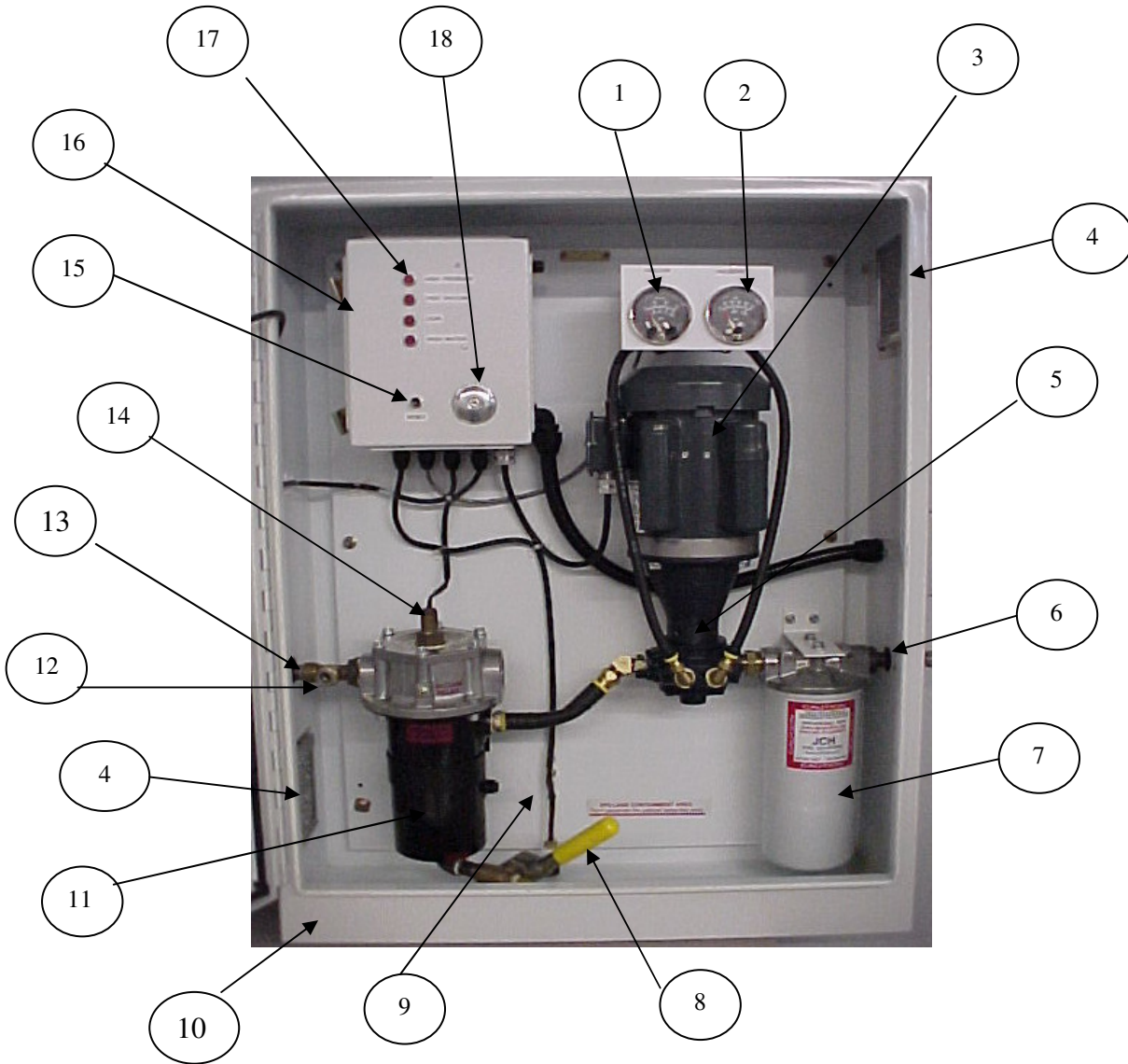

Enviro 3

- | | |
|-------------------------------|-------------------------------|
| 1) Vacuum Switch Gauge | 10) Containment Area (1 1/4") |
| 2) High Pressure Switch Gauge | 11) Strainer Separator #1 |
| 3) Motor (1/2 HP) | 12) Sight Glass |
| 4) Air Vent | 13) Fuel Inlet |
| 5) Pump Assembly (8 GPM) | 14) Water sensor |
| 6) Fuel Outlet | 15) Reset Button |
| 7) Filter #2 (2Micron) | 16) Control Box |
| 8) Drain | 17) Alarm Status Lights |
| 9) Leak Sensor | 18) Audible Hor |
-

Installation

1. **MOUNTING: THE ENVIRO** should be wall mounted on a hard, level surface. This unit can be mounted indoors or outdoors, but should not be mounted in non-ventilated locations. The unit should be located as close to the tank as possible.
2. **ELECTRICAL:** Install a disconnect lockout switch within five (5) feet of **THE ENVIRO**. All wiring should meet NEC or local requirements.

POWER REQUIREMENTS:

120 VAC 50/60 Hz
20 AMP Time Delay
or Thermal Breaker

3. **INLET:** A valve should be installed on the inlet to **THE ENVIRO**. Using the proper fuel approved piping, this line should originate from the lowest available point in the tank.
 - 3/4" NPT female
 - Valve not included
 - All outlet plumbing should be 3/4" or greater
4. **OUTLET:** A valve should be installed on the outlet of **THE ENVIRO**. Fuel approved piping should be plumbed to return fuel to the tank. This line should enter the tank as far away from **THE ENVIRO** suction line as possible.
 - 3/4" NPT female
 - Valve not included
 - All outlet plumbing should be 3/4" or greater

5. Piping should be rigid type. Dual containment piping should be used for any type of underground lines.

IMPORTANT INSTALLATION PRECAUTIONS

Inlet should be independent of the suction line to the engine. If not possible, a check valve must be installed on the outlet side of **THE ENVIRO**.

The outlet should also be independent of the return line from the engine. If return line from the engine and outlet of **THE ENVIRO** are common, a check valve should be installed on the return from engine. (Many engines are already equipped with a check valve - check with engine manufacturer).

If either of the lines from **THE ENVIRO** is common with the lines from the engine, **THE ENVIRO** should be disabled during generator operation. It is recommended that a relay contactor be installed in series with the incoming electrical in conjunction with the run relay of the generator to supply 120 VAC to the red & white #18 AWG wires that are labeled "customer supply power" located inside the workbox on the outside of the unit. The unit will then not clean during generator operation.

Programming Time Switch

CREATING A TIME CHART

THE ENVIRO with its microprocessor-based control can be programmed for daily operation on a seven-day per week basis.

As a guideline we recommend that, under normal circumstances the fuel be re-circulated normal fuel *volume per week*.

Fuel Volume Gallons	Enviro Operation Hours Per Week
2,000	6
1,000	3
500	2

These hours then can be divided into the week for daily operation.

OTHER GUIDELINES FOR OPERATION

- 1.) **THE ENVIRO** should be operated during normal maintenance.
- 2.) Increase use of **THE ENVIRO** during initial long-term fuel storage.
- 3.) Increase use of **THE ENVIRO 3** if frequent filter changes occur.

EXAMPLE:

FUEL QUANTITY: 2,000 GALLONS
ENVIRO Operation: 6 HOURS / WEEK

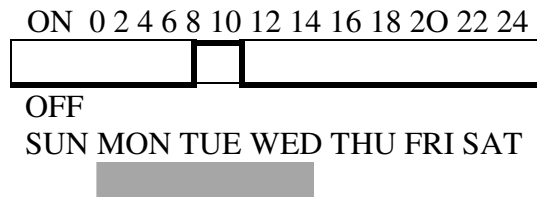

THE ENVIRO runs on at 8:00 and turns off at 10:00 with daily operation Monday through Wednesday for 6 total hours of operation per week.

Parameterizing LOGO!

LOGO! 230RCL

LOGO! 230RCL is a self-contained unit which requires no software for programming. This is accomplished by connecting a series of built-in functions to create the product diagram and is done via the front keypad. The program is stored in EEPROM memory, which saves the program indefinitely, even in the event of a power loss. The unit has a built-in real time clock and day calendar for ease of control.

Setting the clock

1.1 Switching to parameterization mode

To switch to parameterization mode, press **ESC** and **OK** simultaneously:

```
I: 123456
Mo 09:00

Q:1234 RUN
```

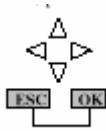

LOGO! switches to parameterization mode and displays the parameterization menu:

```
>Set Clock
Set Param
```

The 'Set Clock' menu item is executed only if your version of LOGO! has a clock/time switch (those versions of LOGO! that have a clock have the letter C in their name, e.g. LOGO 230 RC). 'Set Clock' allows you to set LOGO!'s clock

***NOTE:**

Use 24 Hour Military Time On Enviro 3

Parameterizing LOGO!

1.1.2 Selecting a parameter

To select a parameter, proceed as follows:

1. Select the 'Set Param' option from the parameterization menu

```
Set Clock
>Set Param
```

2. Press **OK**

LOGO! displays the first parameter:

B01:T	←	Parameter
T = 12:00m	←	Value set for the parameter
T _a = 00:00m	←	Current time in logo

If no parameter can be set, LOGO! displays the following:

No Param Press ESC	No parameter can be changed: ESC returns you to the parameterization menu
-----------------------	---

3. Select the desired parameter: ▲ or ▼

LOGO! displays a parameter in a separate window.

4. To change a parameter, select it and press the **OK** key.

Parameterizing LOGO!

1.1.3 Changing a parameter

To change a parameter, you first have to select it (see "Selecting a parameter"). You change the value of the parameter in the same way as you entered it in programming mode:

1. Move the cursor to the point at which you want to make the change:

◀ or ▶

2. Change the value: ▲ or ▼

3. Accept the value: **OK**

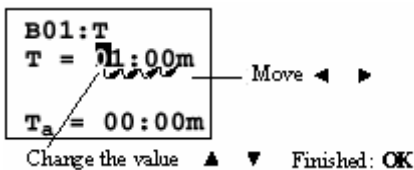

You cannot change the unit of the delay time for the parameter T in parameterization mode. This is only possible in programming mode.

Current value of a time T

If you view a time T in parameterization mode, it looks like this:

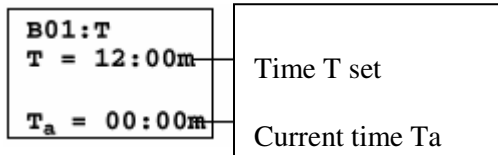

You can change the set time T (see "Changing a parameter").

1.2 Setting the time (LOGO! ... C)

You can set the time:

_ In parameterization mode

_ In programming mode

Setting the time in parameterization mode:

1. Switch to parameterization mode:

ESC and **OK** simultaneously

2. Select 'Set Clock', and press **OK**

04

The cursor is positioned before the day of the week.

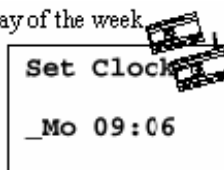
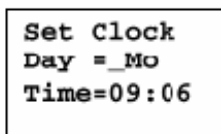

Parameterizing LOGO!

3. Select the day of the week: ▲ or ▼
4. Move the cursor to the next position: ◀ or ▶
5. Change the value at this position: ▲ or ▼
6. Set the clock to the correct time. Repeat steps 4 and 5
7. Conclude your input: **OK**

Setting the time in programming mode:

1. Switch to programming mode:
◀, ▶ and **OK**
 2. Select 'Program..', and press **OK**
 3. Select (using ▼ or ▲) 'Set Clock', and press **OK**
- Now you can set the day of the week and the time, as described above (as of step 3).

Parameterizing LOGO!

Switching between summer and winter time:

LOGO!...L... must be in RUN if you want to switch over the time.

1. If necessary, exit programming or parameterization mode and switch your LOGO!...L... to RUN.

I: 12345678
9 10 11 12
Mo 09:17
Q:12345678

Time displayed

2. Press **OK** and
The current time is put forward by one hour.

I: 12345678
9 10 11 12
Mo 10:17
Q:12345678

Time displayed after change

You change the time in the opposite direction in almost the same way:

3. Press **OK** and **▼**.
The current time is put back by one hour.

I: 12345678
9 10 11 12
Mo 09:17
Q:12345678

Time displayed after change

Alarms

HIGH WATER LEVEL
HIGH VACUUM
CHECK
STRAINER
SEPARATOR #1

Alarm 1 indicates either a clogged strainer on a high water level on strainer separator #1. This housing is located on the left side of the ENVIRO cabinet.

1. **Caution! Combustible!** Read and follow all safety instructions inside door.
2. Shut off electricity to **THE ENVIRO**.
3. Shut off inlet and outlet valve to **THE ENVIRO**.
4. Open bottom valve strainer separator #1 and drain into a clear container a small *amount* of fluid checking for water. Drain all water from housing. To facilitate flow from housing push in air vent. Dispose of fluid in accordance with federal, state and local regulations.
5. Loosen and remove the six bolts on the top of the strainer separator #1 housing utilizing a 1/2" wrench to remove lid.
6. Remove and clean strainer cartridge.
7. Inspect lid gasket and replace if necessary.
8. Reinstall strainer, lid, and bolts on trainer separator housing.
9. Turn inlet and outlet valves back to the open position.
10. Turn electricity back on and push reset button to reset alarm.
11. Check and repair any leaks.

HIGH PRESSURE
FILTER #2
CHANGE FILTER

Alarm 2 indicates a high pressure has occurred on the main filter due to either particulate or water contamination. The main filter is the spin-on filter located on the right side of **THE ENVIRO** cabinet. During this maintenance procedure we recommend that the strainer separator housing #1 be drained to minimize the threat of water contamination of the filter.

1. **Caution! Combustible!** Read and follow safety instruction inside door.
2. Shut off electricity to **THE ENVIRO**.
3. Shut off inlet and outlet valve to **THE ENVIRO**.

Alarms (continued)

4. Open bottom valve strainer separator #1 and drain into a clear container some fluid, checking for water. Drain all water from housing. To facilitate flow from housing push in air vent.
5. Insert a container underneath the main filter. Remove filter slowly by hand, or with a filter wrench, to allow fluid drainage. Dispose of filter and fluid in accordance with federal, state and local regulations.
6. Lubricate and replace gasket in filter adapter.
7. Install new filter and tighten ½ turn after gasket contacts base.
8. Turn inlet and outlet valves back to the open position and push the reset button to reset the alarm.
9. Check and repair any leaks.

CHECK FOR LEAKS

This alarm indicates that liquid has accumulated in the containment area of THE ENVIRO.

1. Check for leaks in THE ENVIRO.
2. Remove fluid from the containment area.
3. Push the reset button to reset the alarm.
4. If leaks occur, either correct the problem or disable unit and shutoff all valves.

MOTOR OVERLOAD

This alarm indicates that a motor overload has occurred.

1. **Caution! Combustible!** Read and follow all safety instructions inside door.
2. Turn off power to **THE ENVIRO**.
3. Open electrical cabinet and push the red reset button on the motor overload relay.
4. After closing the electrical cabinet and tightening screws, turn power back on.
5. Check and repair any leaks.

Fuel Cleaning Systems Warranty

LIMITED WARRANTY

JCH Fuel Solutions makes every effort to assure that our products meet high quality and durability standards and we expressly warrant the products described herein which are manufactured by JCH Fuel Solutions against defects in material and workmanship for a period of one (1) year from the date of purchase. This warranty is not intended to supplant normal inspection, care and service of the products covered hereby by the user, and shall not obligate JCH Fuel Solutions to provide free service during the warranty period to correct breakage, maladjustment or other difficulties arising out of abuse, misuse, or improper care and maintenance of such products. Our express warranty is subject to the following terms and conditions:

1. This warranty shall only extend to and is only for the benefit of original purchasers who use the products covered hereby for commercial or industrial purposes.
2. Any warranty claim received by JCH Fuel Solutions after one (1) year from the date of purchase will not be honored even it is claimed that the defect occurred prior to one (1) year from the date of purchase.
3. This warranty shall not apply to products (1) which have been tampered with, altered or repaired by anyone other than JCH Fuel Solutions without the express prior written consent of JCH Fuel Solutions, (2) which have been installed improperly or subject to misuse, abuse, accident, negligence of others, improper operation or maintenance, neglect or modification, or (3) which have had the serial number altered, defaced or removed.
4. The liability of JCH Fuel Solutions under this warranty is limited to the repair or replacement of the defective product. JCH Fuel Solutions assumes **NO LIABILITY** for labor charges or other costs incurred by any purchaser incidental to the service, adjustment, repair, return, removal or replacement of products. **JCH FUEL SOLUTIONS ASSUMES NO LIABILITY FOR ANY GENERAL, SPECIAL, INCIDENTAL, CONSEQUENTIAL, CONTINGENT OR OTHER DAMAGES UNDER ANY WARRANTY, EXPRESS OR IMPLIED, AND ALL SUCH LIABILITY IS HEREBY EXPRESSLY EXCLUDED.**
5. **JCH FUEL SOLUTIONS MAKES NO WARRANTIES, EXPRESS OR IMPLIED, OF MERCHANTABILITY, FITNESS FOR A PARTICULAR PURPOSE OR OTHERWISE, WITH THE RESPECT TO THE PRODUCTS COVERED BY THIS WARRANTY POLICY, EXCEPT AS EXPRESSLY PROVIDED FOR HEREIN. NO EMPLOYEE, AGENT, REPRESENTATIVE OR DISTRIBUTOR IS AUTHORIZED TO MAKE ANY WARRANTY ON BEHALF OF JCH FUEL SOLUTIONS, OTHER THAN THE EXPRESS WARRANTY PROVIDED FOR HEREIN.**
6. JCH Fuel Solutions reserves the right at any time to make changes in the design, material, function and specifications of its products. Any such changes shall not obligate JCH Fuel Solutions to make similar changes in such products that were previously manufactured.

WARRANTY CLAIM PROCEDURE

To make a claim under this warranty, please call our Customer Service Representative at **(888) 287-1627**. We will ask you to advise us of our Representative's name and address, the date of purchase, model number, serial number and a detailed explanation of the problem you are experiencing. The Customer Service Representative will arrange for a Field Engineer to inspect your system. If the inspection discloses a defect covered by our limited warranty, we will either repair or replace the defective parts or products at our election and at our cost. If upon inspection, our Engineer determines that there is no defect or that the damage to the system resulted from cases not within the scope of our limited warranty, then you must bear the cost of repair or replacement of the damaged parts. For service, please contact **JCH Fuel Solutions**.

JCH Fuel Solutions
4527 Losee Road
N. Las Vegas, NV 89031

Phone: (888) 287-1627 **Fax:** (702) 639-4101 **Direct:** (702) 639-4076

Internet: www.jchfuel.com **E-mail:** sales@jchfuel.com